

超小型信号继电器 Subminiature Signal Relay

1A/2A

特性 / FEATURES

- 4A触点切换能力
Max.4A switching capability
- 高灵敏度、线圈功耗150mW
High sensitive: 150mW
- 标准双列直插引出脚
PCB (DIP)
- 镀金触点
Gold plated contact
- 超小型
Subminiature

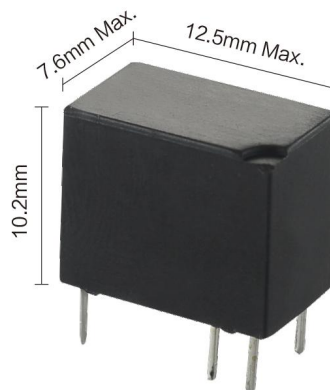

RoHS
Compliant

订购信息 / ORDERING INFORMATION

SRV-12VDC-S L-C

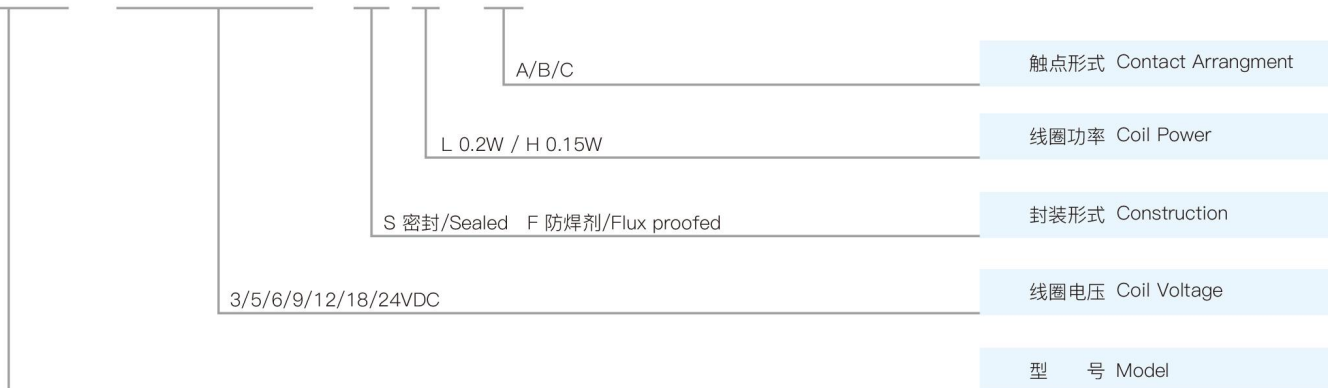

触点参数 / CONTACT PARAMETERS

触点形式	Contact arrangement	A, B, C
接触电阻	Contact resistance	≤50mΩ (1A 6VDC)
触点材质	Contact material	银合金/Silver alloy: AgSnO ₂ In ₂ O ₃ , AgSnO ₂ , AgNi
触点负载(阻性)	Contact rating(Res. load)	1A 120VAC/2A 30VDC
最大切换电压	Max switching voltage	120VAC/60VDC
最大切换电流	Max switching current	4A
最大切换功率	Max switching power	120VA/60W
电耐久性 (频率:每小时360次)	Electrical endurance (Frequency:360 ops/h)	1x10 ⁵ ops / 1x10 ⁴ ops
机械耐久性 (频率:每小时18000次)	Mechanical endurance (Frequency:18000 ops/h)	1x10 ⁷ ops

超小型信号继电器 Subminiature Signal Relay

1A/2A

特性参数 / CHARACTERISTICS PARAMETERS

绝缘等级	Insulation level	A	
绝缘电阻	Insulation resistance	100MΩ(500VDC)	
介质耐压 (漏电流 1mA)	Dielectric strength (Leakage current 1mA)	线圈与触点间 Between coil and contacts	1000VAC 1min
		断开触点间 Between open contacts	500VAC 1min
吸合时间(额定电压下)	Operate time(at nominal voltage)	≤5ms	
释放时间(额定电压下)	Release time (without diode) (at nominal voltage)	≤5ms	
湿度	Humidity	5% ~ 85% RH	
环境温度(°C)	Ambient temperature	-40°C ~ +85°C	
抗冲击	Shock resistance	稳定性/Functional	196m/s ²
		强度/Destructive	980m/s ²
抗振动(双振幅)	Vibration resistance (Double amplitude)	10Hz-55Hz 3.3mm	
重量	Weight	约/Approx 2.2g	
封装形式	Construction	密封/Sealed 防焊剂/Flux proofed	

备注: 以上数据均为初始值

Remark: All above data is initial value

线圈参数 / COIL PARAMETERS

常温/At (23°C)

功耗(W)	Power consumption(W)	0.15W(H)						0.20W(L)					
		03	05	06	09	12	24	03	05	06	09	12	24
额定电压(VDC)	Nominal voltage(VDC)	60	167	240	540	960	3840	45	125	180	405	720	2880
线圈电阻(Ω±10%)	Coil resistance(Ω±10%)												
吸合电压(Max)	Pick-up voltage(Max)	80% 额定电压(Nominal voltage)											
释放电压(Min)	Drop-out voltage(Min)	10% 额定电压(Nominal voltage)											
允许最大电压(VDC)	Max allowable overdrive voltage(VDC)	130% 额定电压(Nominal voltage)											

安全认证(相关认证以第三方认证证书为准) / SAFETY APPROVAL RATINGS



外形图 / OUTLINE DIMENSIONS

单位/Unit(mm)

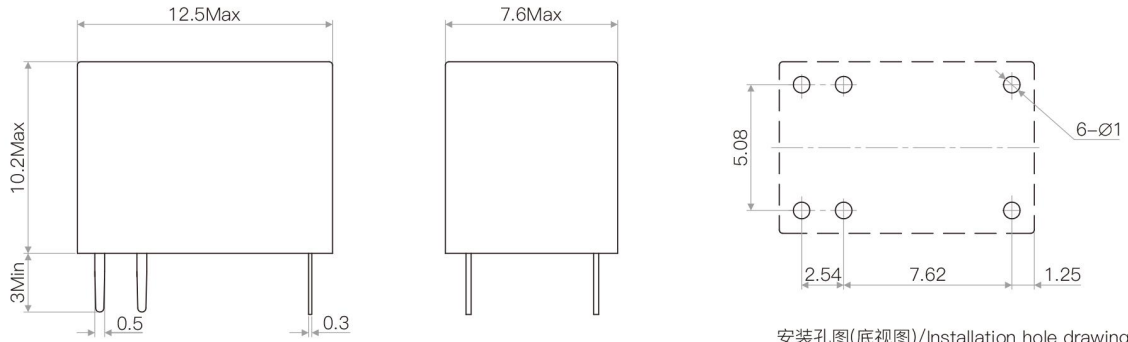

安装孔图(底视图)/Installation hole drawing(Bottom view)

未注公差/Tolerance:±0.1

线路图(底视图) / WIRING DIAGRAM (BOTTOM VIEW)

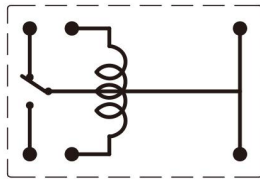

转换C型/Conversion C type

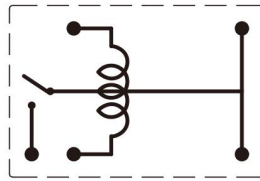

常开A型/Normally open A type

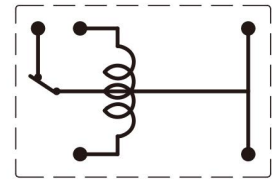

常闭B型/Normally closed B type

性能曲线图 / CHARACTERISTIC CURVES

最大切换功率
Maximum switching power

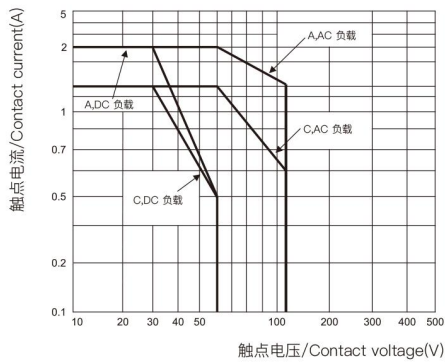

电耐久性曲线
Electrical endurance curve

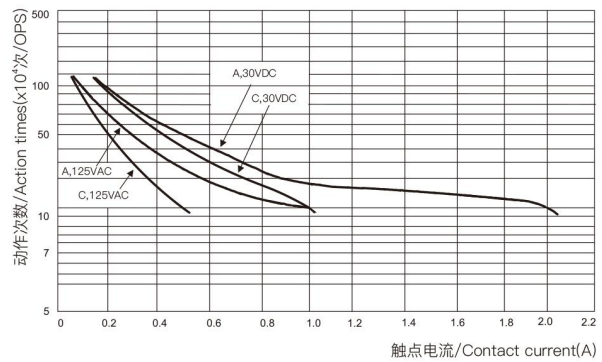

测试条件: 阻性负载, 室温, 1s通9s断

Test conditions: Resistive load, Room temp., 1s on 9s off.